

Data Sheet

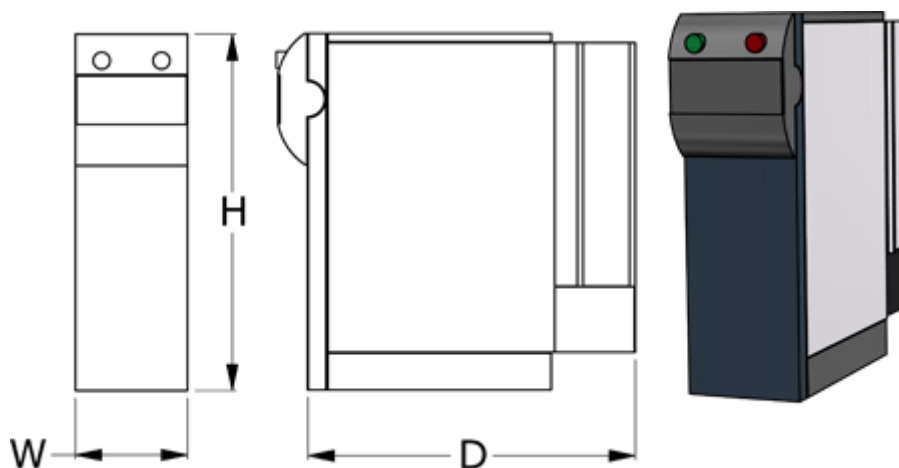

Article number: 1080401011000
Description: Servocontroller ACU401-01-FA
0,25 kW 1A 3x400V IP20

Measures



D = 175
H = 190
W = 60
Weight = 1.2